

MAX-8



MAX-8

Excellent Performances & Reliability

CPC(Q)D15/18/
20/25/30/35T8

T8 series 1.5–3.5t forklift

EP EQUIPMENT CO.,LTD
www.ep-ep.com



CPC(Q)D15/18T8

T8 series 1.5-1.8t forklift specification

		EP								
General	1	Manufacture								
	2	Model		CPCD15T8-S4Q2	CPCD15T8-NB485BPG	CPQD15T8-GK21	CPCD18T8-S4Q2	CPCD18T8-NB485BPG	CPQD18T8-GK21	
	3	Power type		Diesel	Diesel	Gasoline	Diesel	Diesel	Gasoline	
Characteristics & Dimensions	4	Rated capacity		Kg	1500	1500	1500	1800	1800	
	5	Load center		mm	500	500	500	500	500	
	6	Lift height		mm	3000	3000	3000	3000	3000	
	7	Free lift height		mm	120	120	120	120	120	
	8	Fork size		L×W×T	mm	920×100×35	920×100×35	920×100×35	920×100×35	920×100×35
	9	Mast tilt range		F/R	deg	6/12	6/12	6/12	6/12	6/12
	10	Fork overhang(wheel center to fork face)		mm	420	420	420	420	420	
	11	Rear overhang		mm	420	420	420	420	420	
	12	Overall dimensions	Length to face of fork		mm	2230	2230	2230	2230	2230
	13		Overall width		mm	1080	1080	1080	1080	1080
	14		Mast lowered height		mm	1995	1995	1995	1995	1995
	15		Mast extended height		mm	3960	3960	3960	3960	3960
	16		Overhead guard height		mm	2070	2070	2070	2070	2070
	17	Turning radius(outside)		mm	1995	1995	1995	2035	2035	2035
	18	Min.right angle stacking aisle width (Add load length and clearance)		mm	2400	2400	2400	2440	2440	2440
	Performance	19	Travel (No load)		Km/h	14	14	14	14	14
		20	Speed		Lifting (Full load)	mm/sec	460	460	460	460
		21	Lowering (Full load)		mm/sec	450	450	450	450	450
22		Max.Drawbar Pull (Full load)		N	20500(17500)	20500(17500)	20500(17500)	20500(17500)	20500(17500)	
23		Max.Gradeability (Full load)		%	20	20	20	20	20	
Chassis	24	Tyres		Front	mm	6.50-10-10PR	6.50-10-10PR	6.50-10-10PR	6.50-10-10PR	
	25	Rear		mm	5.00-8-10PR	5.00-8-10PR	5.00-8-10PR	5.00-8-10PR	5.00-8-10PR	
	26	Tread		Front	mm	920	920	920	920	
	27	Rear		mm	920	920	920	920	920	
	28	Wheelbase		mm	1430	1430	1430	1430	1430	
	29	Ground clearance		Lowest	mm	110	110	110	110	
	30	Wheelbase center		mm	145	145	145	145	145	
Weight	31	Self weight		Kg	2700	2700	2700	2900	2900	
	32	Full load		Front	kg	3570	3570	3995	3995	
	33	Rear		kg	630	630	705	705		
	34	Distribution		Front	kg	1215	1215	1305	1305	
	35	No load		Rear	kg	1485	1485	1595	1595	
Power & transmission	36	Battery		V/AH	12/60	12/60	12/60	12/60	12/60	
	37	Modal			S4Q2	NB485BPG	GK21	S4Q2	NB485BPG	GK21
	38	Manufacture			Mitsubishi	CHINA	GCT	Mitsubishi	CHINA	GCT
	39	Rated output/r.p.m		kw	32.9/2500	30/2600	31.2/2250	32.9/2500	30/2600	31.2/2250
	40	Rated torque/r.p.m		N.m	135/2000	131/1800	143.7/1600	135/2000	131/1800	143.7/1600
	41	No.of cylinder			4	4	4	4	4	4
	42	Bore×Stroke		mm	88×103	85X100	89×83	88×103	85X100	89×83
	43	Displacement		cc	2505	2270	2065	2505	2270	2065
	44	Fuel tank capacity		L	50	50	50	50	50	50
	45	Manufacture			CHINA	CHINA	CHINA	CHINA	CHINA	CHINA
	46	Type			Powershift	Powershift	Powershift	Powershift	Powershift	Powershift
	47	Stage		FWD/RVS	1/1	1/1	1/1	1/1	1/1	1/1
	48	Operating pressure		For attachments	Mpa	17.5	17.5	17.5	17.5	17.5

1. Special lifting height available (2-stage mast : 2.5m, 2.7m, 3.0m,3.3m, 3.5m,3.6m, 3.7m,4m,4.3m, 4.5m,5m. Full Free Duplex Mast 3.0m,3.3m,3.5m,3.6m, 3-stage mast : 4.3m, 4.5m, 4.8m, 5m, 5.5m, 6m)

2. Attachment available.

3. The parameters in the table are of the standard model. For more information, please contact us. 4. Specification are subject to change without notice.

CPC(Q)D20/25T8

T8 series 2.0-2.5t forklift specification

			EP													
General	1	Manufacture														
	2	Model		CPCD30T8-S4S	CPCD30T8-C490	CPCD30T8-A498	CPCD30T8-C240	CPCD30T8-TD27	CPQD30T8-GK25	CPCD35T8-S4S	CPCD35T8-A498	CPCD35T8-TD27	CPQD35T8-GK25			
	3	Power type		Diesel	Diesel	Diesel	Diesel	Diesel	Gasoline	Diesel	Diesel	Diesel	Gasoline			
	4	Rated capacity	Kg	3000	3000	3000	3000	3000	3000	3500	3500	3000	3500			
Characteristics & Dimensions	5	Load center	mm	500	500	500	500	500	500	500	500	500	500			
	6	Lift height	mm	3000	3000	3000	3000	3000	3000	3000	3000	3000	3000			
	7	Free lift height	mm	120	120	120	120	120	120	120	120	120	120			
	8	Fork size	L×W×T	mm	1070×125×45	1070×125×45	1070×125×45	1070×125×45	1070×125×45	1070×125×45	1070×125×50	1070×125×50	1070×125×45	1070×125×50		
	9	Mast tilt range	F/R	deg	6/12	6/12	6/12	6/12	6/12	6/12	6/12	6/12	6/12	6/12		
	10	Fork overhang(wheel center to fork face)		mm	481	481	481	481	481	481	486	486	481	486		
	11	Rear overhang		mm	590	590	590	590	590	590	590	590	590	590		
	12	Overall dimensions	Length to face of fork	mm	2762	2762	2762	2762	2762	2762	2822	2822	2762	2822		
	13		Overall width	mm	1200	1200	1200	1200	1200	1200	1200	1200	1200	1200		
	14		Mast lowered height	mm	2070	2070	2070	2070	2070	2070	2070	2070	2070	2070		
	15		Mast extended height	mm	4210	4210	4210	4210	4210	4210	4210	4210	4210	4210		
	16		Overhead guard height	mm	2180	2180	2180	2180	2180	2180	2180	2180	2180	2180		
	17	Turning radius(outside)		mm	2450	2450	2450	2450	2450	2450	2510	2510	2450	2510		
	18	Min.right angle stacking aisle width (Add load length and clearance)		mm	2950	2950	2950	2950	2950	2950	3010	3010	2950	3010		
Performance	19	Speed	Travel (No load)	Km/h	20	20	20	20	20	20	20	20	20			
	20		Lifting (Full load)	mm/sec	400	400	400	400	400	400	400	400	400			
	21		Lowering (Full load)	mm/sec	400	400	400	400	400	400	400	400	400			
	22	Max.Drawbar Pull (Full load)	N	21000	21000	21000	21000	21000	21000	21500	21500	21000	21500			
	23	Max.Gradeability (Full load)	%	20	20	20	20	20	20	20	20	20	20			
Chassis	24	Tyres	Front	mm	28×9-15-12PR	28×9-15-12PR	28×9-15-12PR	28×9-15-12PR	28×9-15-12PR	28×9-15-12PR	28×9-15-12PR	28×9-15-12PR	28×9-15-12PR			
	Rear		mm	6.50-10-10PR	6.50-10-10PR	6.50-10-10PR	6.50-10-10PR	6.50-10-10PR	6.50-10-10PR	6.50-10-10PR	6.50-10-10PR	6.50-10-10PR	6.50-10-10PR			
	25	Tread	Front	mm	1010	1010	1010	1010	1010	1010	1010	1010	1010			
	26		Rear	mm	980	980	980	980	980	980	980	980	980			
	27	Wheelbase		mm	1700	1700	1700	1700	1700	1700	1760	1760	1700	1760		
	28	Ground clearance	Lowest		140	140	140	140	140	140	140	140	140	140		
	29		Wheelbase center		175	175	175	175	175	175	175	175	175	175		
Weight	30	Self weight		Kg	4450	4450	4450	4450	4450	4450	4700	4700	4450	4700		
	31	Weight Distribution	Full load	Front		6488	6488	6488	6488	6488	7134	7134	6488	7134		
	32			Rear		962	962	962	962	962	1066	1066	962	1066		
	33		No load	Front		1810	1810	1810	1810	1810	1810	1927	1927	1810	1927	
	34			Rear		2640	2640	2640	2640	2640	2640	2773	2773	2640	2773	
35	Battery	Voltage/Capacity(20HR)	V/AH	12/60	12/80	12/80	12/80	12/80	12/60	12/60	12/80	12/80	12/60			
Power & transmission	36	Engine	Modal		S4S-DPEU2	C490BPG-25	A498BT1-39	C240	TD27	GK25	S4S-DPEU2	A498BT1-39	TD27	GK25		
	37		Manufacture		Mitsubishi	CHINA	CHINA	ISUZU	GCT	GCT	Mitsubishi	CHINA	GCT	GCT		
	38		Rated output/r.p.m	kw	35.3/2250	36.8/2650	36.8/2400	34.5/2500	38.5/2300	37.4/2300	35.3/2250	36.8/2400	38.5/2300	37.4/2300		
	39		Rated torque/r.p.m	N.m	177/1700	156/1700-1900	186/1600-1800	139/1800	160/2300	176.5/1600	177/1700	186/1600-1800	160/2300	176.5/1600		
	40		No. of cylinder		4	4	4	4	4	4	4	4	4	4		
	41		Bore×Stroke	mm	94×120	90×105	95×105	86×102	96/92	89×100	94×120	95×105	96/92	89×100		
	42		Displacement	cc	3331	2670	2980	2369	2663	2488	3331	2980	2663	2488		
	43		Fuel tank capacity	L	70	60	70	70	60	70	75	70	60	75		
	44		Manufacture		CHINA	CHINA	CHINA	CHINA	CHINA	CHINA	CHINA	CHINA	CHINA	CHINA	CHINA	
	45		Transmissions	Type		Powershift	Powershift	Powershift	Powershift	Powershift	Powershift	Powershift	Powershift	Powershift	Powershift	
	46			Stage	FWD/RVS		1/1	2/2	2/2	1/1	1/1	1/1	1/1	2/2	1/1	1/1
	47			Operating pressure	For attachments	Mpa	17.5	17.5	17.5	17.5	17.5	17.5	17.5	17.5	17.5	17.5

1. Special lifting height available (2-stage mast : 2.5m, 2.7m, 3.0m,3.3m, 3.5m,3.6m, 3.7m,4m,4.3m, 4.5m,5m. Full Free Duplex Mast 3.0m,3.3m,3.5m,3.6m. 3-stage mast : 4.3m, 4.5m, 4.8m, 5m, 5.5m, 6m)

2. Attachment available.

3. The parameters in the table are of the standard model. For more information, please contact us. 4. Specification are subject to change without notice.

CPC(Q)D30/35T8

T8 series 3.0-3.5t forklift specification

		EP										
1	Manufacture											
2	Model		CPCD20T8-S4S	CPCD20T8-C490	CPCD20T8-C240	CPCD20T8-TD27	CPQD20T8-GK25	CPCD25T8-C490	CPCD25T8-S4S	CPCD25T8-C240	CPCD25T8-TD27	CPCD25T8-GK25
3	Power type		Diesel	Diesel	Diesel	Diesel	Gasoline	Diesel	Diesel	Diesel	Diesel	Gasoline
4	Rated capacity	Kg	2000	2000	2000	2000	2000	2500	2500	2500	2500	2500
5	Load center	mm	500	500	500	500	500	500	500	500	500	500
6	Lift height	mm	3000	3000	3000	3000	3000	3000	3000	3000	3000	3000
7	Free lift height	mm	120	120	120	120	120	120	120	120	120	120
8	Fork size	L×W×T	mm	1070×120×40	1070×120×40	1070×120×40	1070×120×40	1070×120×40	1070×120×40	1070×120×40	1070×120×40	1070×120×40
9	Mast tilt range	F/R	deg	6/12	6/12	6/12	6/12	6/12	6/12	6/12	6/12	6/12
10	Fork overhang(wheel center to fork face)	mm	476	476	476	476	476	476	476	476	476	476
11	Rear overhang	mm	485	485	485	485	485	550	550	550	550	550
12	Overall dimensions	Length to face of fork	mm	2610	2610	2610	2610	2610	2660	2660	2660	2660
13		Overall width	mm	1150	1150	1150	1150	1150	1150	1150	1150	1150
14		Mast lowered height	mm	2050	2050	2050	2050	2050	2050	2050	2050	2050
15		Mast extended height	mm	4200	4200	4200	4200	4200	4200	4200	4200	4200
16	Overhead guard height	mm	2130	2130	2130	2130	2130	2130	2130	2130	2130	2130
17	Turning radius(outside)	mm	2170	2170	2170	2170	2170	2230	2230	2230	2230	2230
18	Min.right angle stacking aisle wiath (Add load length and clearance	mm	2680	2680	2680	2680	2680	2740	2740	2740	2740	2740
19	Speed	Travel (No load)	Km/h	20	20	20	20	20	20	20	20	20
20		Lifting (Full load)	mm/sec	450	450	450	450	450	450	450	450	450
21		Lowering (Full load)	mm/sec	450	450	450	450	450	450	450	450	450
22	Max.Drawbar Pull (Full load)	N	17500	17500	17500	17500	17500	17500	17500	17500	17500	17500
23	Max.Gradeability (Full load)	%	20	20	20	20	20	20	20	20	20	20
24	Tyres	Front	mm	7.00-12-12PR	7.00-12-12PR	7.00-12-12PR	7.00-12-12PR	7.00-12-12PR	7.00-12-12PR	7.00-12-12PR	7.00-12-12PR	7.00-12-12PR
25		Rear	mm	6.00-9-10PR	6.00-9-10PR	6.00-9-10PR	6.00-9-10PR	6.00-9-10PR	6.00-9-10PR	6.00-9-10PR	6.00-9-10PR	6.00-9-10PR
26	Tread	Front	mm	970	970	970	970	970	970	970	970	970
27		Rear	mm	970	970	970	970	970	970	970	970	970
28	Wheelbase	mm	1600	1600	1600	1600	1600	1600	1600	1600	1600	1600
29	Ground clearance	Lowest	mm	120	120	120	120	120	120	120	120	120
30		Wheelbase center	mm	145	145	145	145	145	145	145	145	145
31	Self weight	Kg	3580	3580	3580	3580	3580	3920	3920	3920	3920	3920
32	Weight Distribution	Full load	Front	kg	4856	4856	4856	4856	5588	5588	5588	5588
33			Rear	kg	724	724	724	724	832	832	832	832
34		No load	Front	kg	1428	1428	1428	1428	1560	1560	1560	1560
35			Rear	kg	2152	2142	2142	2142	2360	2360	2360	2360
36	Battery	V/AH	12/60	12/80	12/80	12/80	12/60	12/80	12/60	12/60	12/60	12/60
37	Modal		S4S-DPEU2	C490BPG-25	C240	TD27	GK25	C490BPG-25	A498BT1-39	C240	TD27	GK25
38	Manufacture		Mitsubishi	CHINA	ISUZU	GCT	GCT	CHINA	Mitsubishi	ISUZU	GCT	GCT
39	Rated output/r.p.m	kw	35.3/2250	36.8/2650	34.5/2500	38.5/2300	37.4/2300	36.8/2650	35.3/2250	34.5/2500	38.5/2300	37.4/2300
40	Rated torque/r.p.m	N.m	177/1700	156/1700-1900	139/1800	160/2300	176.5/1600	156/1700-1900	177/1700	139/1800	160/2300	176.5/1600
41	No.of cylinder		4	4	4	4	4	4	4	4	4	4
42	Bore×Stroke	mm	94×120	90×105	86×102	96/92	89×100	90×105	94×120	86×102	96/92	89×100
43	Displacement	cc	3331	2670	2369	2663	2488	2670	3331	2369	2663	2488
44	Fuel tank capacity	L	60	60	60	60	60	60	60	60	60	60
45	Manufacture		CHINA	CHINA	CHINA	CHINA	CHINA	CHINA	CHINA	CHINA	CHINA	CHINA
46	Transmissions	Type		Powershift	Powershift	Powershift	Powershift	Powershift	Powershift	Powershift	Powershift	Powershift
47	Stage	FWD/RVS		1/1	2/2	1/1	1/1	2/2	1/1	1/1	1/1	1/1
48	Operating pressure	For attachments	Mpa	17.5	17.5	17.5	17.5	17.5	17.5	17.5	17.5	17.5

1. Special lifting height available (2-stage mast : 2.5m, 2.7m, 3.0m,3.3m, 3.5m,3.6m, 3.7m,4m,4.3m, 4.5m,5m. Full Free Duplex Mast 3.0m,3.3m,3.5m,3.6m, 3-stage mast : 4.3m, 4.5m, 4.8m, 5m, 5.5m, 6m)

2. Attachment available.

3. The parameters in the table are of the standard model. For more information, please contact us.

4. Specification are subject to change without notice.

RATED CAPACITIES AND LOAD CENTERS GRAPH

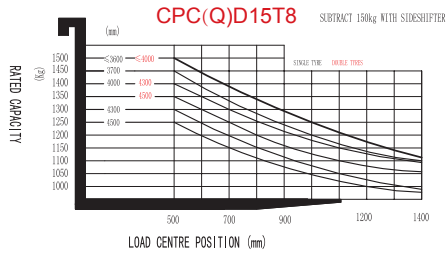

RATED CAPACITIES AND LOAD CENTERS GRAPH

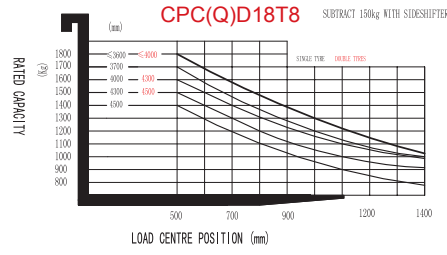

RATED CAPACITIES AND LOAD CENTERS GRAPH

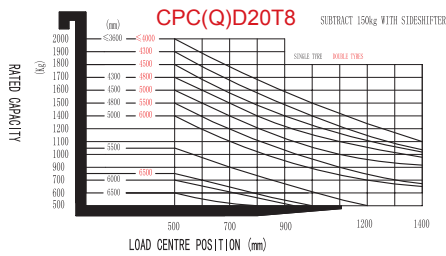

RATED CAPACITIES AND LOAD CENTERS GRAPH

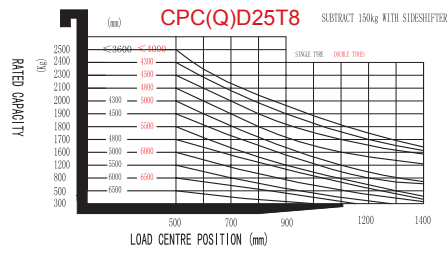

RATED CAPACITIES AND LOAD CENTERS GRAPH

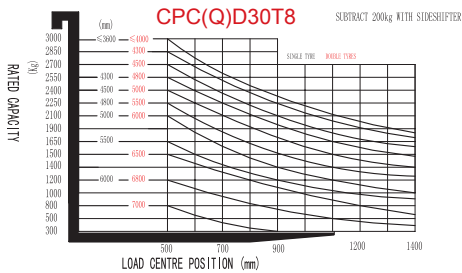

RATED CAPACITIES AND LOAD CENTERS GRAPH

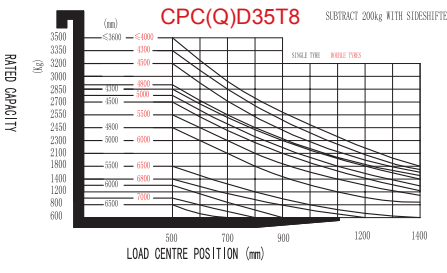

Option

Options	15/18T8	20/25T8	30T8	35T8
1 Fork length	○	○	○	○
2 Fork extension	○	○	○	○
3 Folded fork	○	○	○	○
4 Imported diesel engine	○	○	○	○
5 Import Gasoline Engine	○	○	○	○
6 LPG system	○	○	○	○
7 High exhaust	○	○	○	○
8 Dual air cleaners or special air cleaner	○	○	○	○
9 Solid rubber tire	○	○	○	○
10 No marking solid tire	○	○	○	○
11 Overhead guard	●	●	●	●
12 Mast options	○	○	○	○
13 Attachments	○	○	○	○
14 Integrated side shift	○	○	○	○
15 Cockpit	●	●	●	●
16 heater	○	○	○	○
17 Front windshield with wiper	○	○	○	○
18 Rear windshield with wiper	○	○	○	○
19 Fan	○	○	○	○
20 Full steel cabin room	○	○	○	○
21 LED front light	●	●	●	●
22 Rear working LED light	○	○	○	○
23 Fire extinguisher	○	○	○	○
24 Suspension seat	○	○	○	○
25 Seat switch	●	●	●	●
26 Warning light	●	●	●	●
27 Insulation mat	○	○	○	○
28 Double front tyre	○	○	○	○
29 OPS system	○	○	○	○

Note: ● standard ○ option — NA

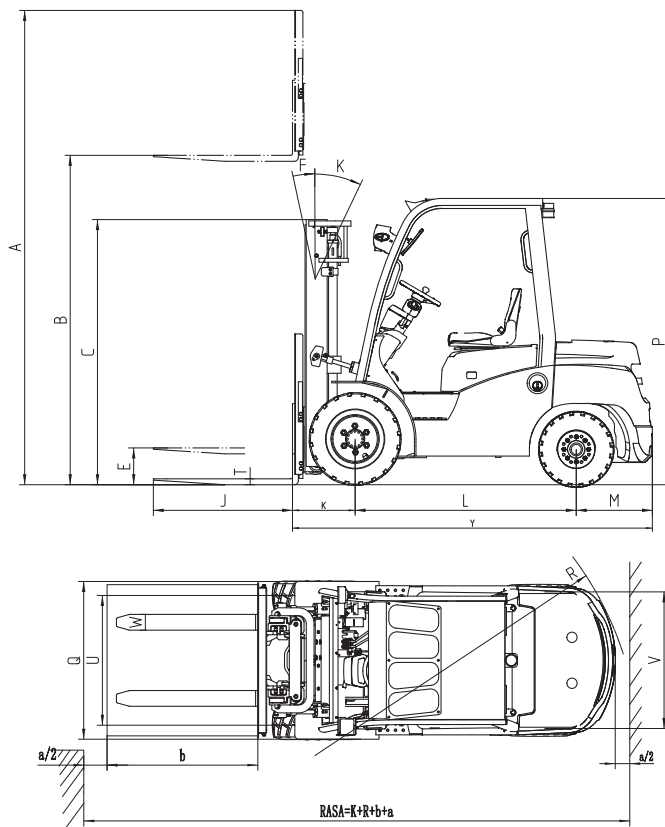

SKLAD TRUCK

ОФИЦИАЛЬНЫЙ ДИСТРИБЬЮТОР БРЕНДА EP EQUIPMENT

+380 73 972 1163

skladtruck.com.ua

info@skladtruck.com.ua

EP
Let's grow together